

# POWER

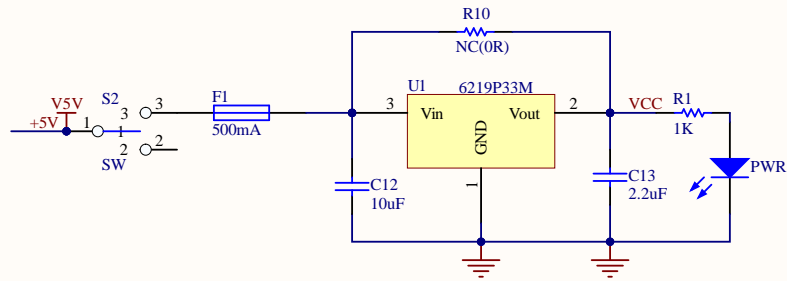

# LED

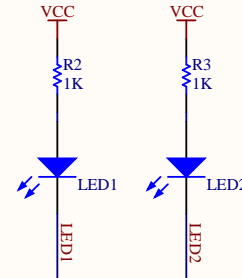
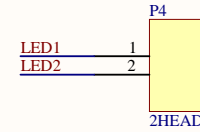

# USB

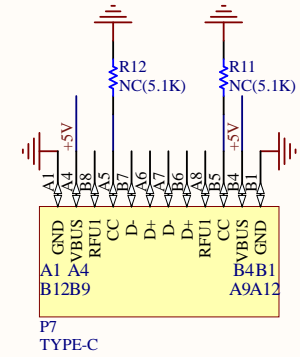

# MCU

## CH32V003F4P6\_MINI

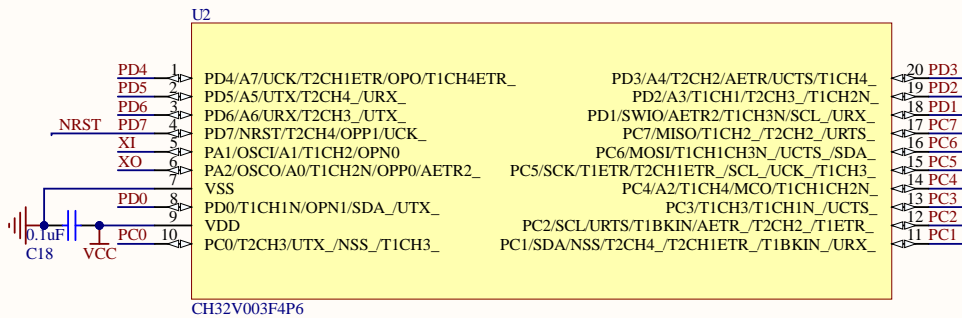

## VCC-Support 5V and 3.3V

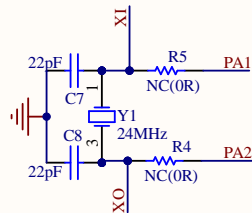

# PIN

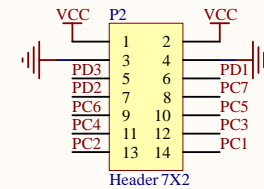
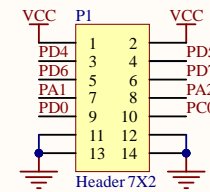

# RST

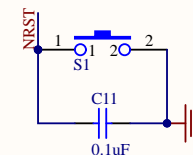

# OPA

